

TIME RESPONSE MEASUREMENTS OF ANGRA I NUCLEAR POWER PLANT USING DIRECT AND INDIRECT METHODOLOGIES

**Iraci Martinez Pereira Gonçalves¹, Roberto Carlos dos Santos¹,
Wagner José dos Reis Lopes² and Olivio da C. Napolitano²**

¹ Instituto de Pesquisas Energéticas e Nucleares (IPEN / CNEN - SP)
Av. Professor Lineu Prestes 2242
05508-000 São Paulo, SP
martinez@ipen.br
rcsantos@ipen.br

² Eletrobrás Termonuclear S.A – Eletronuclear
Rodovia BR 101 km 522 Rio de Janeiro,RJ
wrlopes@eletronuclear.gov.br
olivio@eletronuclear.gov.br

ABSTRACT

Estimation of sensor response characteristics is necessary to satisfy requirements on allowable response time for nuclear power plants. The methodology currently used includes direct and indirect measurements each of them having its vantages and disadvantages. The objective of this work is to compare the time response measurements of temperature and pressure sensors of the Brazilian Angra I nuclear power plant obtained using direct and indirect methodologies. Direct methods give more precise results, but need special equipments do be carried out and interfere with the reactor operation. Indirect methodology is most practical of being performed; it does not interfere with the reactor operation because the sensors do not have to be out of operation. On the other hand, since the parameter identification depends on the noise characteristics, there are cases where indirect methodology is not suitable to predict time response.

1. INTRODUCTION

Sensor time response measurement represents an important requirement to be observed in the maintenance of a nuclear reactor protection system. This measurement has to be performed periodically to ensure that the protection reactor limits are respected [1]. There are different methodologies developed to determine the time constant for temperature and pressure sensors. The methodologies current used to determine sensor time response are listed in Table 1.

Table 1. Direct and indirect methodologies used to determine sensor time response

	Test	Sensor
Direct	LCSR – Loop Current Step Response	Temperature
	Ramp Pressure	Pressure
	OFF-ON	Pressure
Indirect	Noise Analysis	Temperature and pressure

Direct methodologies consist in applying a transient to the sensor to be monitored using specific test equipment. The time response is obtained direct from the test (OFF-ON and Ramp Pressure tests) or from a posterior data analysis (LCSR test). LCSR test is performed during normal plant operation, but the sensor's leads need to be disconnected from their in-plant transmitters. On the other hand, the ramp pressure test is performed while the plant is out of operation.

The indirect method consists in doing the analysis of the noise from the sensors, and the information about the dynamic behavior of the sensor is obtained with a minimal interference during the normal operation of the nuclear power plant. The sensor time response is obtained from a data analysis in the frequency domain using spectral analysis techniques.

2. DIRECT METHODOLOGIES

2.1. Loop Current Step Response Test – LCSR

The direct methodology for temperature measurements is the Loop Current Step Response – LCSR, used to determine time constant for Resistance Temperature Detector-RTD sensors. The test consists in applying a small current to the RTD leads that heats the sensor filament and the temperature transient due to a step change is analyzed to determine the response time that would have followed a fluid temperature change. The LCSR data gives the sensor response of an internal heating perturbation, but the response of interest is the one that results from a fluid temperature perturbation. An analytical transformation was developed to predict the response to a fluid temperature perturbation by using information from the LCSR data record [2].

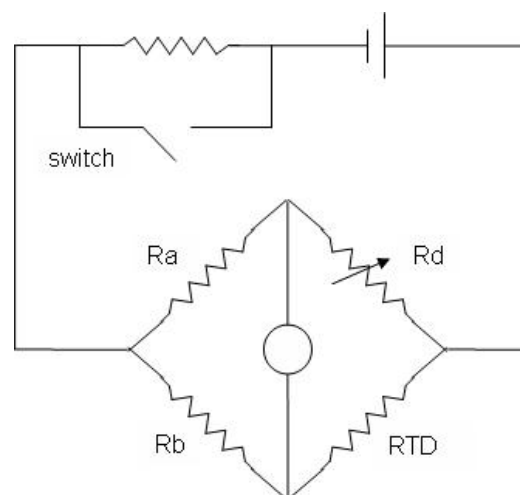

Figure 1. Schematic of the loop current step response test equipment.

The LCSR test equipment consists in a Wheatstone bridge with current switching capability (Figure 1). The switch can be opened or closed to decrease or increase the current. The LCSR test is made by connecting a test instrument at the point where the sensor leads are normally connected to their in-plant transmitter (Figure 2). Figure 3 shows a typical LCSR test result.



Figure 2. LCSR test equipment.

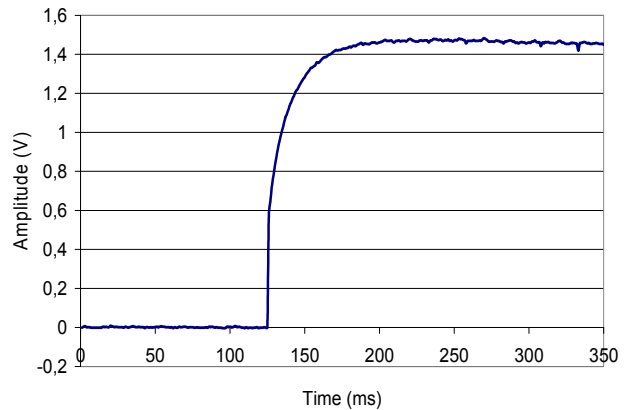

Figure 3. A typical LCSR data.

2.2. OFF-ON Test

The Power Interrupt methodology, also called OFF-ON technique, is performed remotely from the control room while the plant is on-line and is performed by switching the transmitter power OFF for a few seconds and then ON. The signal is monitored during the test and analyzed to obtain the sensor response time [3]. This test is applicable only to force balance pressure transmitters. Figure 4 shows an OFF-ON test, where τ is the sensor time constant.

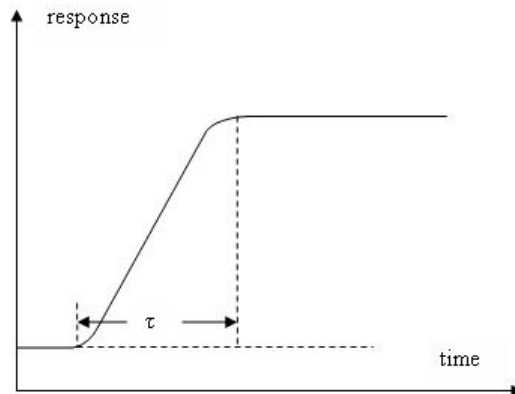

Figure 4. OFF-ON test transient.

2.3. Ramp Pressure Test

The Ramp Pressure test consists in simultaneously applying a pressure transient to the sensor and to a fast reference sensor and compares both responses to determine the time delay between them [4]. This test is applicable to all kinds of pressure sensors but needs to be performed using specific test equipment connected as close as possible to the sensor, and requires that the sensor be out of operation. Figure 5 shows the equipment used to perform the

Ramp Pressure test. Figure 6 shows an Ramp Pressure test, where τ is the sensor time constant. This equipment was developed to determine the time constant of a low pressure range sensors. Figure 7 shows a typical Ramp Pressure test result of a Barton sensor. The fast reference sensor is a Validyne sensor.



Figure 5. Ramp pressure test equipment.

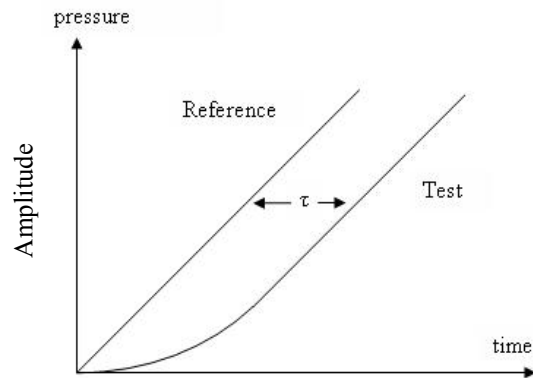

Figure 6. Ramp pressure test.

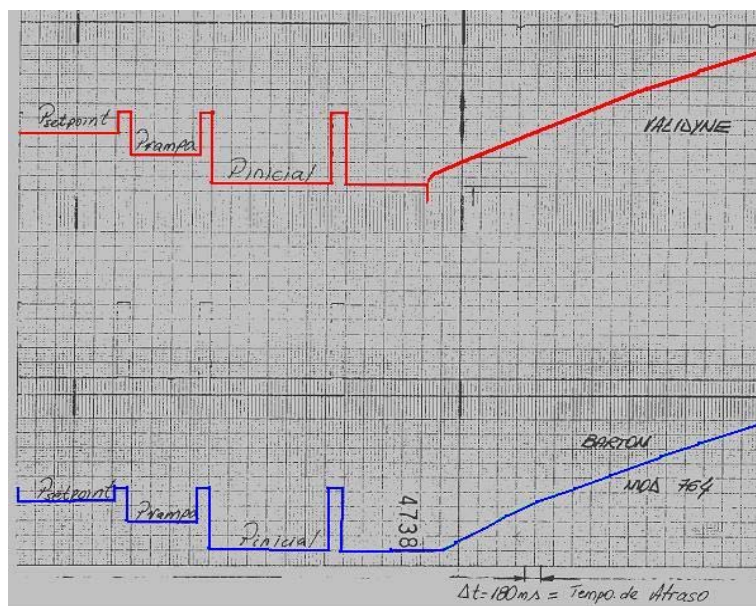

Figure 7. A pressure ramp test result.

3. INDIRECT METHODOLOGY - NOISE ANALYSIS

The indirect method consists in the analysis of the noise from the sensors. Random noise techniques for measurements on nuclear reactor systems have been developed as a tool for system surveillance or to analyse dynamic behaviour with a minimum of interference during normal operation [5]. Random variations in the neutron flux density, temperature, steam flow or pressure may be used to derive useful information about the system dynamics or to monitor sensor characteristics.

Noise signals may be interpreted using spectral techniques or empirical time series models. The frequency domain method consists of evaluating the Power Spectral Density (PSD) function. The information needed for time constant estimation can be obtained by fitting an all-pole transfer function to this power spectral density. If the system has only one dominant pole, then the time constant of interest can be obtained from the break frequency of the Power Spectral Density curve (Figure 8). Sensors' signals are filtered and amplified before acquired using a data acquisition system connected to a PC (Figure 9).

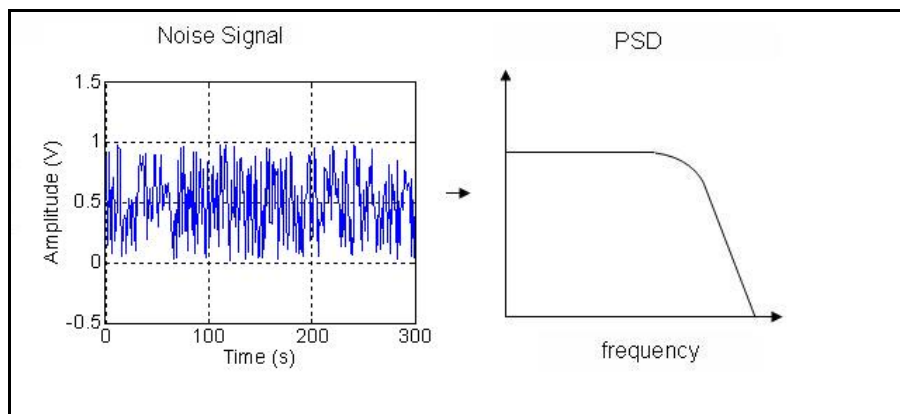

Figure 8. Noise analysis test.



Figure 9. Isolating amplifiers used in the noise analysis methodology.

4. RESULTS

Figures 10 and 11 show a result of LCSR test for a fast and a slow RTD temperature sensor.

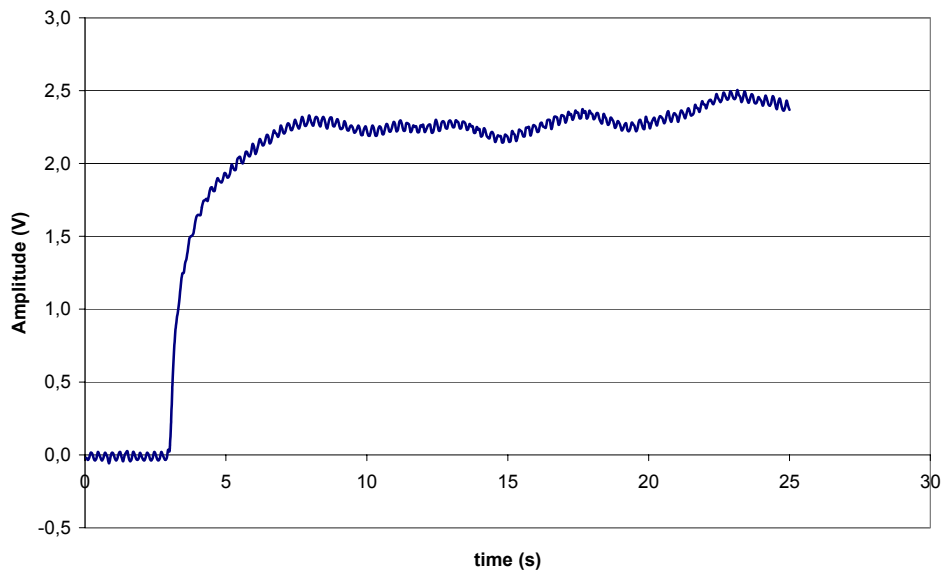

Figure 10. A typical LCSR test result for a fast RTD temperature sensor.

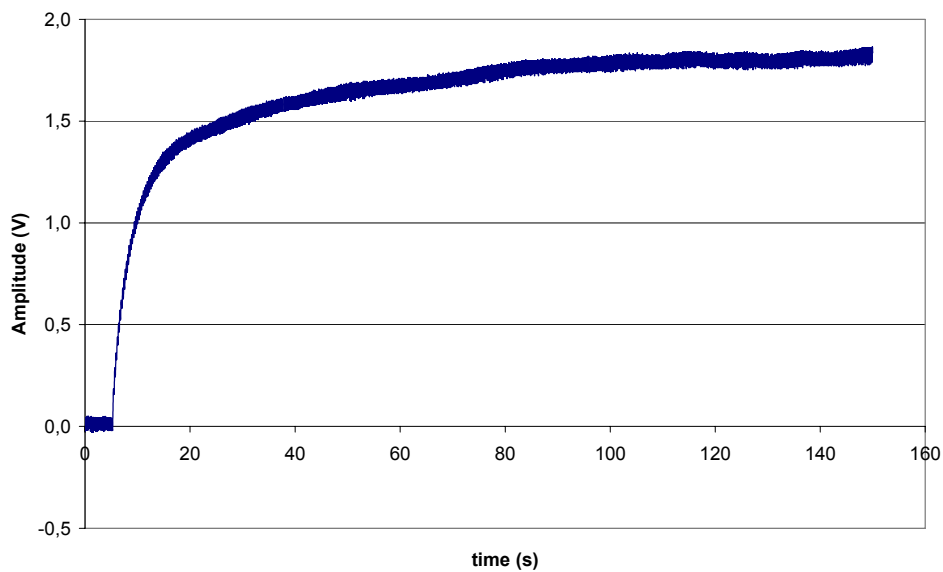

Figure 11. A typical LCSR test result for a slow RTD temperature sensor.

Data obtained from a pressure sensor was analyzed in the frequency domain and the Power Spectral Density function correspondent is shown in Figure 12. Since the parameter identification depends on the noise characteristics, there are cases where the random signal variation is not suitable to predict time response.

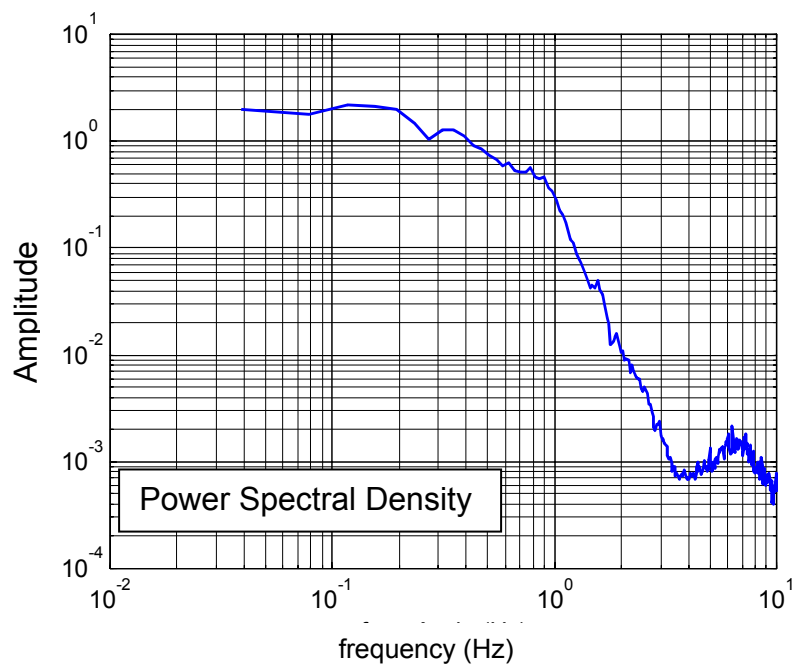

Figure 12. A typical noise analysis test result.

5. CONCLUSIONS

Basically the methodologies currently used to determine sensors' time response can be classified into direct and indirect methodology. The direct methodology for temperature measurements is the Loop Current Step Response – LCSR, used to determine time constant for resistance temperature sensors RTD. The test consists in applying a small current to the RTD leads and the temperature transient due to a step change that heats the sensor filament is analyzed to determine the response time that would have followed a fluid temperature change. The test is made by connecting a test instrument at the point where the sensor leads are normally connected to their in-plant transmitter.

There are two different kinds of direct methodologies for pressure sensor time response measurements. The first one is the Power Interrupt methodology also called OFF-ON technique that is performed remotely from the control room while the plant is on-line. The test is performed by switching the transmitter power OFF for a few seconds and then ON. The signal is monitored during the test and analyzed to obtain the sensor response time. This test is applicable only to force balance pressure transmitters. The second direct test is the Ramp Pressure Test which consists in simultaneously applying a pressure ramp to the sensor and to a fast reference sensor and compare both responses to determine the time delay between them. This test is applicable to all kinds of pressure sensors but needs to be performed using specific test equipment connected as close as possible to the sensor, and requires that the sensor be out of operation which in some cases is possible only if the plant is off-line.

The indirect method consists in doing the analysis of the noise from the sensors, and the information about the dynamic behavior of the sensor is obtained with a minimal interference

during the normal operation of the nuclear power plant. The sensor time response is obtained from a data analysis in the frequency domain using spectral analysis techniques. Noise Analysis' tests can be applied to all kind of sensors, but it is not suitable to signals with low random noise levels.

Direct methods give more precise results, but need special equipments do be carried out and interfere with the reactor operation. Indirect methodology is most practical of being performed; it does not interfere with the reactor operation because the sensors do not have to be out of operation.

The results obtained from Angra 1 NPP's instrumentation have been showing a great evolution of the process implemented and developed by IPEN. Response time test is a Regulatory Organization (CNEN) requirement and it need to be performed in each outage for refueling or in case of one transmitter need to be replaced.

Therefore, response time test, even direct or indirect methodologies, will continue to be performed in order to satisfy new technical specification requirement, determining the temperature and pressure sensors time response. Besides, the use of IPEN's team has saved money, once Angra 1 does not need to have this service from other countries.

ACKNOWLEDGMENTS

The authors would like to thank the operation and instrumentation staff of Angra I nuclear power plant for their helping during the tests.

REFERENCES

1. U.S Nuclear Regulatory Commission. *Periodic Testing of Electric Power and Protection Systems*, New York, N.Y, Nov. 1977. (NUREG 1.118).
2. B. R., Upadhyaya, T. W., Kerlin, "In Situ Response Time of Platinum Resistance Thermometers". **Vol. 2**, .Palo Alto, *Electric Power Research Institute EPRI NP-834*, July 1978.
3. A. J. Soares, T. W. Kerlin, L. F. Miller, "Dynamic Analysis of a Foxboro Force Balance Pressure Transducer", *Transactions of the American Nuclear Society* **Vol. 43**, pp. 742 (1982).
4. Cain, D. G. and Foster, G. C. "A Practical Means for Pressure Transducer Response Verification". *Nuclear Technology*, **Vol. 36**, Mid-December 1977.
5. B. R. Upadhyaya, T. W. Kerlin, "Estimation of Response Time Characteristics of Platinum Resistance Thermometers by the Noise Analysis Technique", *ISA Transactions*, **Vol. 17**, No. 4, pp. 21-38 (1978).